



USER MANUAL

MD65X DIGITAL MOBILE RADIO





Welcome to the world of Hytera and thank you for purchasing this product. This manual includes a description of the functions and step-by-step procedures for use. It also includes a troubleshooting guide. To avoid bodily injury or property loss caused by incorrect operation, please carefully read the *Safety Information Booklet* before use.

This manual is applicable to the following product:

MD65X Digital Mobile Radio (X may represent 2, 5, 6, or 8)

Instructional Icons



: Indicates functions that are available on digital channel only.



: Indicates functions that are available on analog channel only.

Functions marked with neither the above icons are available on both analog and digital channels.

Disclaimer

Hytera Communications Corporation Limited (the Company) endeavors to achieve the accuracy and completeness of this manual, but no warranty of accuracy or reliability is given. All the specifications and designs are subject to change without notice due to continuous technology development. No part of this manual may be copied, modified, translated, or distributed in any manner without the express written permission of us.

We do not guarantee, for any particular purpose, the accuracy, validity, timeliness, legitimacy or completeness of the Third Party products and contents involved in this manual.

If you have any suggestions or would like to learn more details, please visit our website at: <http://www.hytera.com>.

RF Radiation Information

This product must be restricted to operations in an occupational/controlled RF exposure environment. Users must be fully aware of the hazards of the exposure and able to exercise control over their RF exposure to qualify for the higher exposure limits.

RF Radiation Profile

Radio Frequency (RF) is a frequency of electromagnetic radiation in the range at which radio signals are transmitted. RF technology is widely used in communication, medicine, food processing and other fields. It may generate radiation during use.

RF Radiation Safety

In order to ensure user health, experts from relevant industries including science, engineering, medicine and health work with international organizations to develop standards for safe exposure to RF radiation. These standards consist of:

- United States Federal Communications Commission, Code of Federal Regulations; 47CFR part 2 sub-part J;
- American National Standards Institute (ANSI)/Institute of Electrical and Electronic Engineers (IEEE) C95.1-1992;
- Institute of Electrical and Electronic Engineers (IEEE) C95.1-1999;
- International Commission on Non-Ionizing Radiation Protection (ICNIRP) 1998.

FCC Regulations

Federal Communication Commission (FCC) requires that all radio communication products should meet the requirements set forth in the above standards before they can be marketed in the U.S, and the manufacturer shall post a RF label on the product to inform users of operational instructions, so as to enhance their occupational health against exposure to RF energy.

Operational Instructions and Training Guidelines

To ensure optimal performance and compliance with the occupational/controlled environment RF energy exposure limits in the above standards and guidelines, users should transmit not more than 50% of the time and always adhere to the following procedures:



- Antenna gain must not exceed 5dBi for UHF or 3.5dBi for VHF.
- The antenna installation must comply with the requirements of manufacturer or supplier, and it must be 1 meter away from human body.

EU Regulatory Conformance

As certified by the qualified laboratory, the product is in compliance with the essential requirements and other relevant provisions of 2014/53/EU.

Please note that the above information is applicable to EU countries only.

Contents

Items in the Package	2
Product Overview	3
Radio Unit	3
Remote Speaker Microphone	3
Installation	3
Instructions	3
Installation Tools	3
Installation Procedure	3
Status Indication	4
LCD Icon	4
LED Indicator	4
Basic Operations	5
Powering On/Off	5
Adjusting the Volume	5
Selecting a Zone	5
Selecting a Channel	5
Setting TX Power Level	5
Call Services	5
Calls on Digital Channel 	5
Calls on Analog Channel (No Signaling) 	5
Features	6
Troubleshooting	6
Care and Cleaning	7
Optional Accessories	7

Items in the Package

Please unpack carefully and check that all items listed below are received. If any item is missing or damaged, please contact your dealer.

1 Radio Unit

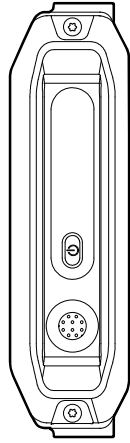

2 Remote Speaker Microphone

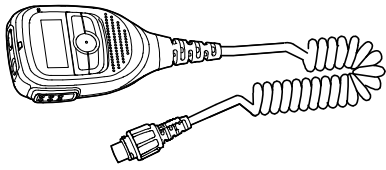

3 Hanger and Screws for Remote Speaker Microphone

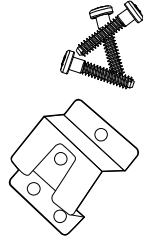

4 Power Cord

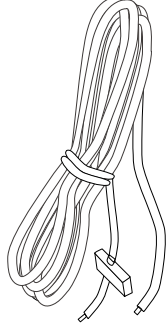

5 Fuse



6 Mounting Bracket Kit

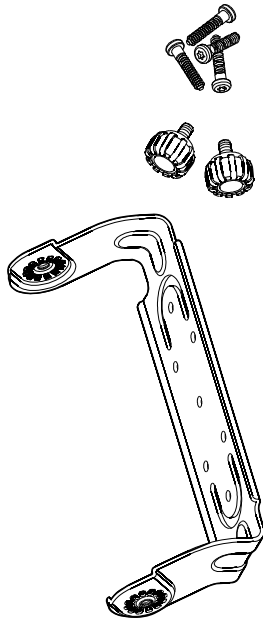

7 GPS Antenna

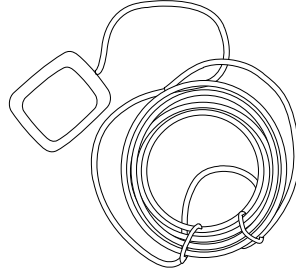

8 Documentation Kit



Note:

- The GPS antenna is the standard accessory for the MD65X with GPS feature. The frequency band is marked on the label of antenna; if not, please refer to the label on the radio for frequency band information.
- Unless otherwise specified, the remote speaker microphone mentioned in this manual refers to that included in the item list.

Product Overview

Radio Unit

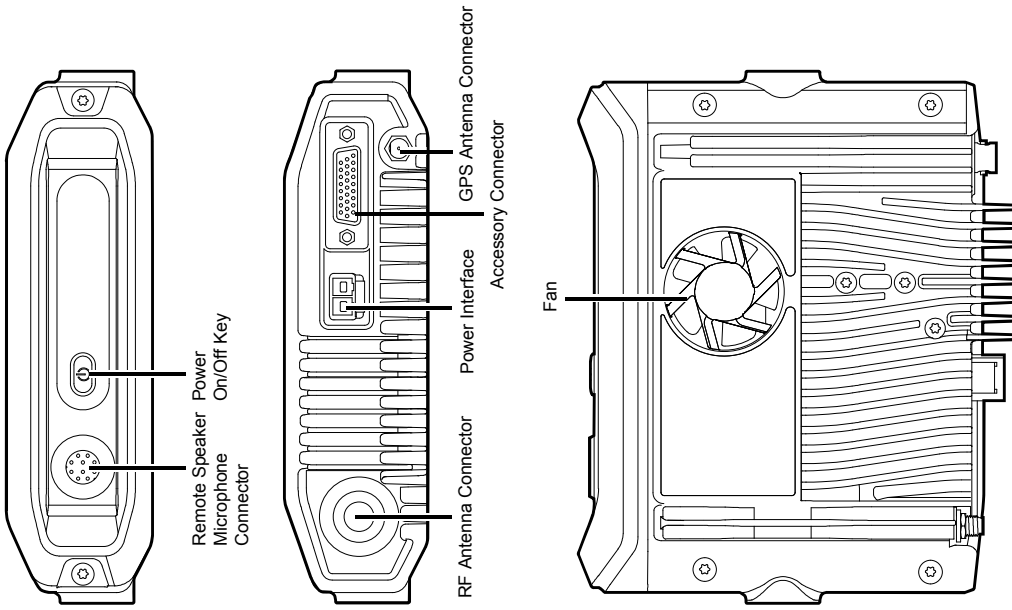

Caution:

- GPS antenna connector is for MD65X mobile radio with GPS feature only.
- Do not block the ventilation hole of the fan.
- Clean the fan regularly.
- Do not stop the fan with hard objects such as a screwdriver to avoid fan damage.
- Do not touch the fan blades when the fan operates to avoid bodily injury.

Remote Speaker Microphone

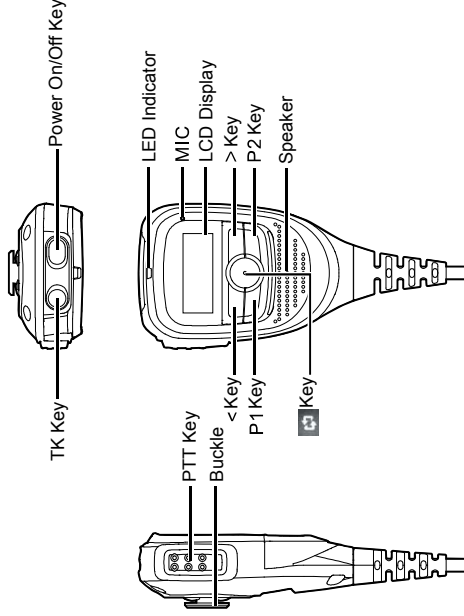

For enhanced convenience, you may request your dealer to program the **TK**, **P1** and **P2** keys as shortcuts to certain functions. You may refer to the corresponding Feature Book for more details.



Caution: The **TK** is programmed with emergency feature by default (short press: Emergency On; long press: Emergency Off). It is programmable by your dealer.

Installation

Instructions

Before you install the radio in a vehicle, be sure to read the following instructions carefully:

- The radio must work with a 13.6V±15% negative ground electrical system only. And ensure to check the ground polarity and voltage of the vehicle power supply prior to installation.
- Check how long the screws will extend from the bottom surface of the radio before installation. Drill the mounting hole cautiously to avoid damage to the vehicle wiring and other parts.
- Connect the antenna and power cord to the radio, before you install it in the bracket. And make sure the antenna and power cord are dedicated for digital radios of the Company.
- Install the radio with the mounting bracket supplied by the Company, to avoid radio looseness in case of accidents. The loose radio may cause bodily injury.
- Install the radio in a location where it's easy to reach the front panel controls.
- Keep sufficient clearance at the back of the radio for wiring.
- Be sure to use the fuse with the same specification for DC power cord upon replacement.
- If there are any other device in the vicinity of this radio, the distance between the antenna of this radio and the antenna of such RF device shall be no less than 10 meters.

Installation Tools

- Drill
- Cross head screwdriver
- Hex socket sleeve (for 4.8×20mm self-tapping screws assembling)

Installation Procedure

To install the radio, do as follows:

1. Install the **bracket** in a location where it's easy to operate the radio.
2. Connect accessories such as the **antenna** and **power cord** to the radio.
3. Slide the **radio** into the properly mounted bracket and secure it using the locking knobs.
4. Install the **remote speaker microphone hanger** in a location where it can be reached conveniently.
5. Plug the **remote speaker microphone** into the radio, but at first align the triangle index on the **remote speaker microphone** with the microphone installation index on the microphone connector. Place the remote speaker microphone on the hanger when you do not use it.

The parts of the radio are illustrated below:

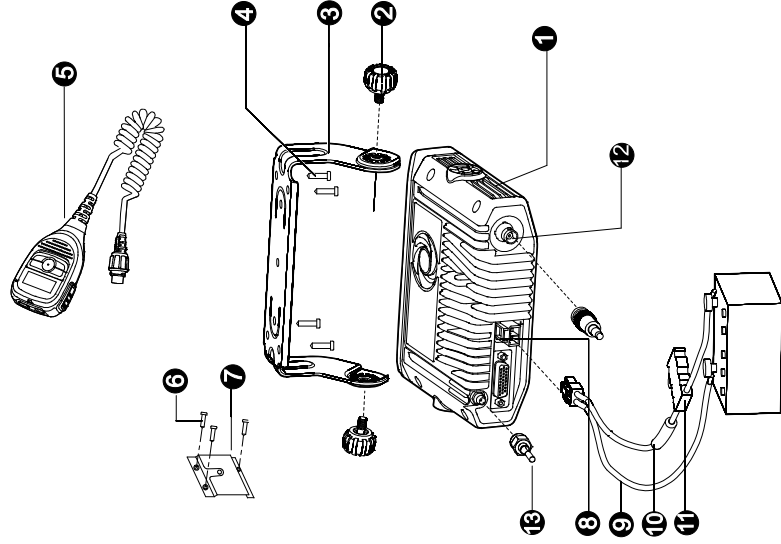

Status Indication

The LCD display and LED indicators on the remote speaker microphone indicate the operation status of the radio.

LCD Icon

Icon Name	Icon	Radio Status
Scan Icon		The radio is scanning.
		The radio stays on a non-priority channel.
		The radio stays on Priority Channel 1.
Roam Icon		The radio stays on Priority Channel 2.
		The radio is roaming.
Volume Icon		More bars indicate higher volume.
Channel Icon	CHXX	Indicates the current channel. "XX" denotes the channel number, such as "CH01".
Zone Icon	ZONEXX	Indicates the current zone. "XX" denotes the zone number, such as "ZONE01".
TX Power Icon		Low TX power for the current channel.
		High TX power for the current channel.

LED Indicator

LED Indication	Radio Status
The LED indicator flashes green.	Powering on
The LED indicator glows red.	Transmitting
The LED indicator glows green.	Receiving
The LED indicator flashes orange slowly.	Scanning or roaming
The LED indicator flashes orange rapidly.	Emergency
The LED indicator glows orange.	Call hung. During a call, you can hold down the PTT key to talk to the other party before the call hang time expires.

Icon Name	Icon	Radio Status
RSSI Icon		More bars indicate better signal strength.
GPS Icon		The GPS feature is enabled, and valid GPS data is received.
		The GPS feature is enabled, but no valid GPS data is received.

Basic Operations

Powering On/Off

Method 1

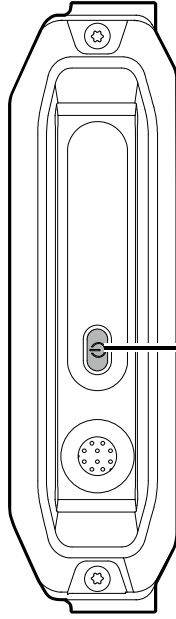



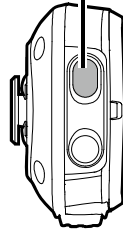

Long press to power on/off

Method 2



Long press to power on/off

Adjusting the Volume

1. Press the  key on the remote microphone speaker until the icon  is shadowed.
2. Press the  key to lower the volume and press the  key to increase it.

Selecting a Zone

A zone is a group of channels exhibiting the same property, which is programmed by your dealer and can facilitate convenient management over the channel. The radio supports 64 zones, each of which consists of up to 16 channels.

To select a zone, do as follows:

1. Press the  key on the remote microphone speaker until ZONEXX (e.g. ZONE01) is shadowed.
2. Press the  /  key to select a zone.



Selecting a Channel

1. Press the  key on the remote microphone speaker until CHXX (e.g. CH01) is shadowed.
 2. Press the  /  key to select a channel.
- If the Channel Notify feature is enabled by your dealer, the radio will announce the channel number upon channel switching.

Setting TX Power Level

This feature is to set the TX power level to high or low. High power can extend the signal coverage of the radio, enabling you to communicate with farther radios. Generally, we recommend you to adopt low power for battery saving. However, if you cannot communicate with radios located at a distant place with low power, please select high power.

To set the TX power level, do as follows:

1. Press the  key on the remote microphone speaker until the TX power level icon (e.g. ) is shadowed.
2. Press the  /  key to switch power level.

Call Services

After the radio is powered on, you can make and receive calls. To ensure optimal volume of the receiving radio, keep the palm microphone about 2.5 to 5 centimeters away from your mouth when transmitting.

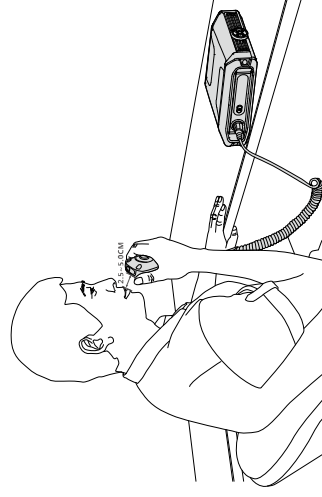

Calls on Digital Channel

You can initiate a private call, group call or all call (your radio must be programmed to allow you to use the all call service) through the same operations on digital channel.

When calling back, the radio will make a call to the calling party in private call and all call (your radio must be programmed to allow you to call back in an all call); but in group call, the radio will make a call to all parties involved. Here takes the private call between Radio A and Radio B as example:

1. Radio A and B select the same digital channel.
2. Radio A holds down the **PTT** key to initiate a call. Radio A may preset a regular private call/group call/all call contact for each digital channel via the dealer.
3. By holding down the **PTT** key, Radio A can talk to the microphone when the LED indicator on the radio glows red.
4. Radio A releases the **PTT** key to finish talking. Radio A can hold down the **PTT** key to talk when the LED indicator on the radio is glowing orange. When receiving, the LED indicator on the radio glows green.
5. Radio B can receive the call without any operation. When receiving, the LED indicator glows green.
6. Radio B can hold down the **PTT** key to talk when the LED indicator on the radio is glowing orange.



Note: The Call Hang Time (the duration of LED indicator glowing orange) is preset by your dealer. If neither party talk before this duration expires, the call will end.





Calls on Analog Channel (No Signaling)

On the analog channel without signaling, the calling operations are the same as that on the digital channel. The difference is that the called parties are all the users on the channel, rather than the preset contact for the channel.

Please refer to the corresponding Feature Book for operation description on how to make and receive calls on the analog channel with signaling.

Features

Available features of this radio are listed below. Please refer to the corresponding Feature Book for details.

Feature Type	Detailed Feature
Radio Features	<ul style="list-style-type: none"> Radio setting: Power Level, LED Indicator and Alert Tone Convenient functionality: Shortcuts, One Touch Call and VOX Security: Lone Worker Rent Audio Optimization Positioning
Conventional Common Features	<ul style="list-style-type: none"> Scan Talk Around Access management Basic voice services: Private Call and Group Call (See Calls on Digital Channel  in this manual) Auxiliary voice services: All Call (See Calls on Digital Channel  in this manual) and Phone Security Supplementary services Patented features Mobility management
Digital Features 	<ul style="list-style-type: none"> Access management Voice services (See Calls on Analog Channel (No Signaling)  in this manual) Security Signaling
Analog Features 	<ul style="list-style-type: none"> API Accessory Connector

Troubleshooting

Phenomena	Analysis	Solution
The radio fails to power on.	The power cord may be disconnected.	Properly connect the power cord.
During receiving, the voice is weak, discontinuous or totally inactive.	The volume level may be low.	Increase the volume via the remote speaker microphone.
	The antenna may be loosened or improperly installed.	Power off the radio and reattach the antenna.
	The speaker may be blocked or damaged.	Clean the surface of the speaker. If the problem cannot be solved, contact your dealer or authorized service center for inspection and repair.
You cannot communicate with other members in analog mode.	The frequency or signaling may not match that of other members. You may be too far away from the group members.	Set your TX/RX frequency and signaling to the same as that of other members. Move towards other members.
In digital mode, there's RX indication on the radio, but unable to communicate with other members.	The digital carrier may be received but may not be demodulated due to inconsistent ID with that of other members.	Sets the same ID of other members.
Irrelevant communication or noise is heard on the channel.	You may be interrupted by radios using the same frequency.	Adjust the squelch level.
	The radio may be set with no signaling.	Set your radio with signaling to avoid interference at the same frequency, and make sure that all members share the same signaling.
The noise is too loud.	You may be too far away from other members.	Move towards other members, and then try again.
	You may locate in an unfavorable position. For example, your communication may be blocked by high buildings or frustrated in the underground areas.	Move to an open and flat area, and restart the radio to try again.
	You may suffer from external disturbance (such as electromagnetic interference).	Stay away from equipment that may cause interference.
No indication on the LCD of the remote speaker microphone.	The LCD may fail to function temporarily.	Restart the radio or reassemble the remote speaker microphone.
GPS positioning failure.	The GPS antenna may be connected improperly.	Properly connect the GPS antenna.
	GPS signals may not be received due to unfavorable position.	Move to an open and flat area to try again.

If the above solutions cannot fix your problems, or you may have some other queries, please contact us or your local dealer for more technical support.

Care and Cleaning

To guarantee optimal performance as well as a long service life of the product, please follow the tips below.

Product Care

- Do not pierce or scrape the product.
- Keep the product far away from substances that can corrode the circuit.
- Do not hold the product by its antenna or earpiece cable directly.
- Attach the accessory connector cover when the accessory is not in use.

Product Cleaning



Caution: Turn off the product and disconnect the power supply before cleaning.

- Clean up the dust and fine particles on the product surface and charging piece with a clean and dry lint-free cloth or a brush regularly.
- Use neutral cleanser and a non-woven fabric to clean the keys and front case after long-time use. Do not use chemical preparations such as stain removers, alcohol, sprays or oil preparations, so as to avoid surface case damage.
- Make sure the product is completely dry before use.

Optional Accessories

The following items are the main optional accessories for the radio. For more information of other accessories, please consult your local dealer.



Caution: Use the accessories specified by the Company only. If not, the Company shall not be liable for any loss or damage arising out of use of unauthorized accessories.

Accessory Type	Model/Name
Power Supply	PS22002 Power Supply for Mobile Radio (220W, Backup Power Supply applicable)
Audio	SM09D1 External Speaker PC37 DB26-connector Programming Cable (USB port)
Cable	PC47 Programming Cable (USB port) PC49 Back-to-back Data Cable (DB26 to DB26)
Others	Omni-directional Antenna



is the trademark or registered trademark of
Hytera Communications Corporation Limited.

© 2014 Hytera Communications Corporation Limited. All Rights Reserved.

Address: HYT Tower, Hi-Tech Industrial Park North, Beihuan
RD., Nanshan District, Shenzhen, China

Postcode: 518057

<http://www.hytera.com>